

**EN-7517C / EN-7519C  
17" / 19" PREMIUM  
TFT-LCD MONITOR**



Please read this manual thoroughly before use, and keep it handy for future reference.

# CONTENTS

SAFETY INSTRUCTION .....	2 ~ 3
CAUTIONS .....	4
FCC RF INTERFERENCE STATEMENT .....	5
CONNECTING WITH EXTERNAL EQUIPMENT .....	6
REMOTE FUNCTIONS .....	7
CONTROLS AND FUNCTIONS .....	8 ~ 30
MOUNTING GUIDE .....	31
D-SUB CONNECTOR PIN ASSIGNMENTS .....	32
POWER MANAGEMENT .....	33
SPECIFICATIONS .....	34
TROUBLE SHOOTING GUIDE .....	35

# SAFETY INSTRUCTION

This Monitor was  
Manufactured by ISO 9001  
Certified Factory

**INSTRUCTION MANUAL** ..... 1

## Important Safety Instruction

1. Read these instructions.
2. Keep these Instructions.
3. Heed all warnings.
4. Follow all instructions.
5. Do not use this apparatus near water.
6. Clean only with dry cloth.
7. Do not block any ventilation openings. Install in accordance with the manufacturer's instructions.
8. Do not install near any heat sources such as radiators, heat registers, stoves, or other apparatus (including amplifiers) that produce heat.
9. Do not defeat the safety purpose of the polarized or grounding-type plug.  
A polarized plug has two blades with one wider than the other.  
A grounding type plug has two blades and a third grounding prong.  
The wide blade or the third prong are provided for your safety.  
If the provided plug does not fit into your outlet, consult an electrician for replacement of the obsolete outlet.
10. Protect the power cord from being walked on or pinched particularly at plugs, convenience

receptacles and the point where they exit from the apparatus.

11. Only use attachment/accessories specified by the manufacturer.
12. Use only with the cart, stand, tripod, bracket or table specified by the manufacturer or sold with the apparatus. When a cart is used, use caution when moving the cart/apparatus combination to avoid injury from tip-over.
13. Unplug this apparatus during lightning storms or when unused for long periods of time.
14. Refer all servicing to qualified service personnel. Servicing is required when the apparatus has been damaged in any way, such as power-supply cord or plug is damaged, liquid has been spilled or objects have fallen into the apparatus the apparatus has been exposed to rain or moisture does not operate normally or has been dropped.



# SAFETY INSTRUCTION

## 2 ..... *INSTRUCTION MANUAL*

- The apparatus shall not be exposed to dripping or splashing and that no objects filled with liquids, such as vases, shall be placed on the apparatus.
- Minimum distances(e.g. 10cm) around the apparatus for sufficient ventilation.

“WARNING - To reduce the risk of fire or electric shock, do not expose the apparatus to rain or moisture.”

“The apparatus shall not be exposed to dripping or splashing and no objects filled with liquids, such as vases, shall be placed on the apparatus.”

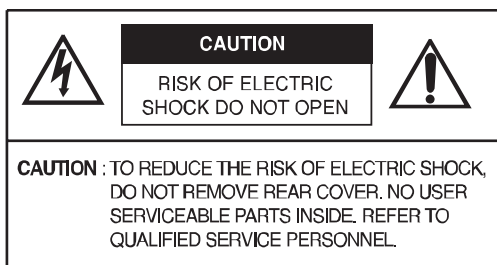

This symbol is intended to alert the user to the presence of uninsulated : dangerous voltage with in the product's enclosure that may be of sufficient magnitude to constitute a risk of electric shock to persons.



This symbol is intended to alert the user to the presence of important operating and maintenance(servicing) instructions in the literature accompanying the appliance.

## CAUTIONS

**INSTRUCTION MANUAL** ..... 3

### **CAUTION**

*The power supply cord is used as the main disconnect device, ensure that the socket-outlet is located/installed near the equipment and is easily accessible.*

### **ATTENTION**

*Le cordon d'alimentation est utilisé comme interrupteur général. La prise de courant doit être située ou installée à proximité du matériel et être facile d'accès*

**CAUTION TO SERVICE PERSONNEL**

POWER SUPPLY CORD IS USED AS MAIN POWER DISCONNECT DEVICE IN THIS PRODUCT. UNPLUG THIS PRODUCT FROM THE WALL OUTLET BEFORE REMOVING THE BACK COVER AND SERVICING

**EMISSION CHARACTERISTICS TESTED BY SEMKO**

THIS PRODUCT HAS BEEN TESTED AND HAS SHOWN COMPLIANCE WITH THE NATIONAL SPECIFICATIONS SUCH AS SWEDISH MPR 1990.10.(MPR II)

**NEVER REMOVE THE BACK COVER**

Removal of the back cover should be carried out only by qualified personnel.

**DO NOT USE IN HOSTILE ENVIRONMENTS**

To prevent shock or fire hazard, do not expose the unit to rain or moisture.

This unit is designed to be used in the office or home. Do not subject the unit to vibrations, dust of corrosive gases.

**KEEP IN A WELL VENTILATED PLACE**

Ventilation holes are provided on the cabinet to prevent the temperature from rising.

Do not cover the unit or place anything on the top of unit.

**AVOID HEAT**

Avoid placing the unit in direct sunshine or near a heating appliance.

**TO ELIMINATE EYE FATIGUE**

Do not use the unit against a bright back ground and where sunlight or other light sources will shine directly on the monitor.

**BE CAREFUL OF HEAVY OBJECT**

Neither the monitor itself nor any other heavy object should rest on the power cord.

# FCC RF INTERFERENCE STATEMENT

Damage to a power cord can cause fire or electrical shock.

**NOTE**

This equipment has been tested and found to comply with the limits for a Class A digital device, pursuant to Part 15 of the FCC Rules. These limits are designed to provide reasonable protection against harmful interference in a residential installation.

This equipment generates, uses and can radiate radio frequency energy and, if not installed and used in accordance with the instructions, may cause harmful interference to radio communications. However, there is no guarantee that interference will not occur in a particular installation.

If this equipment does cause harmful interference to radio or television reception which can be determined by turning the equipment off and on, the user is encouraged to try to correct the interference by one or more of the following measures.

- Reorient or relocate the receiving antenna.
- Increase the separation between the equipment and receiver.
- Connect the equipment into an outlet on a circuit different from that to which the receiver is connected.
- Consult the dealer or an experienced radio, TV technician for help.
- Only shielded interface cable should be used.

Finally, any changes or modifications to the equipment by the user not expressly approved by the grantee or manufacturer could void the users authority to operate such equipment.

**☐ DOC COMPLIANCE NOTICE**

This digital apparatus does not exceed the Class A limits for radio noise emissions from digital apparatus set out in the radio interference regulation of Canadian Department of communications.



# CONNECTING WITH EXTERNAL EQUIPMENT

## A. BOTTOM PANEL CONTROL

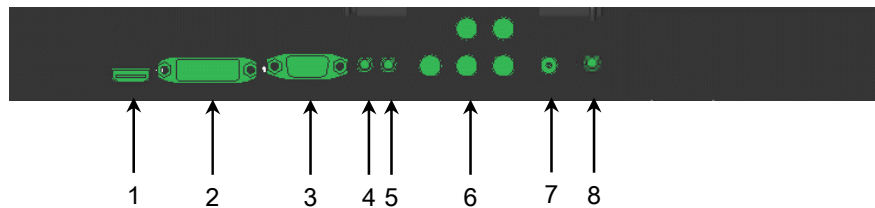

1. HDMI IN
2. DVI IN
3. VGA(D-SUB) IN
4. PC STEREO IN
5. AUDIO OUT(Speaker)
6. COMPONENT Y,Pb,Pr & SOUND L,R IN
7. DC 12V IN
8. TRIGGER INPUT

## B. SIDE PANEL CONTROL

1. VIDEO1(AV1) IN
2. VIDEO1(AV1) OUT
3. VIDEO2(AV2) IN
4. VIDEO2(AV2) OUT
5. S-VIDEO(Y/C) IN
6. S-VIDEO(Y/C) OUT
7. AV1 & S-VIDEO AUDIO IN
8. AV1 & S-VIDEO AUDIO OUT
9. AV2 AUDIO IN
10. AV2 AUDIO OUT
11. DC 12V ADAPTOR

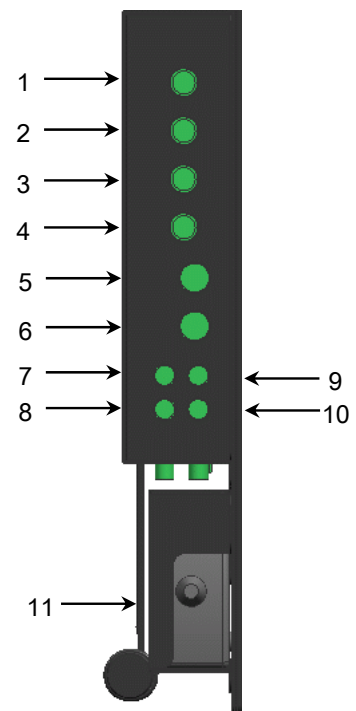

# REMOTE FUNCTIONS

## C. REMOTE CONTROLLER (Option)

### 1. POWER(⏻)

Turn the power ON or OFF. There will be a few seconds delay before the display appears.

### 2. SOURCE

Select pc or video(AV1/AV2/S-Video/Component/HDMI/DVI/PC) sources.

### 3. AUTO

Auto geometry adjustment in PC Source.

### 4. HOLD

Stop the Trigger & Auto switching functions.

### 5. MUTE

Mute the sound.

### 6. MENU

Activates and exits the On Screen Display.

### 7. EXIT

Exit the On Screen Display.

### 8. VOL(◀▶)

Increases or decreases the level of audio volume.

### 9. UP/DOWN

Move to OSD menu.

### 10. SOURCE/SELECT

Accept your selection or displays the current mode.

### 11. INFO

Input mode information Display.

### 12. STILL

Stop the picture.

### 13. PIP (Picture In Picture)

Activate PIP mode.

### 14. P.INPUT

Change source of sub picture in PIP mode.

### 15. P.POS

Move the position of sub picture for PIP mode.

### 16. P.SIZE

Change the size of sub and main picture for PIP mode.

### 17. SWAP

Alternates between main and sub picture.

### 18. ARC (Aspect Ratio Control)

Select screen ratio.

### 19. APC (Auto Picture Control)

Select picture mode.

### 20. ACC (Auto Color Control)

Select Colour mode.

### 21. S.SET

Select Sound mode main input or sub input

### 22. PC

Select PC mode(PC, DVI & HDMI).

### 23. AV



# CONTROLS AND FUNCTIONS

Select AV mode.(AV1, AV2 & S-VIDEO).

## 24. COMP

Select COMPONENT mode.

**INSTRUCTION MANUAL** ..... 7

## D. FRONT KEY CONTROL

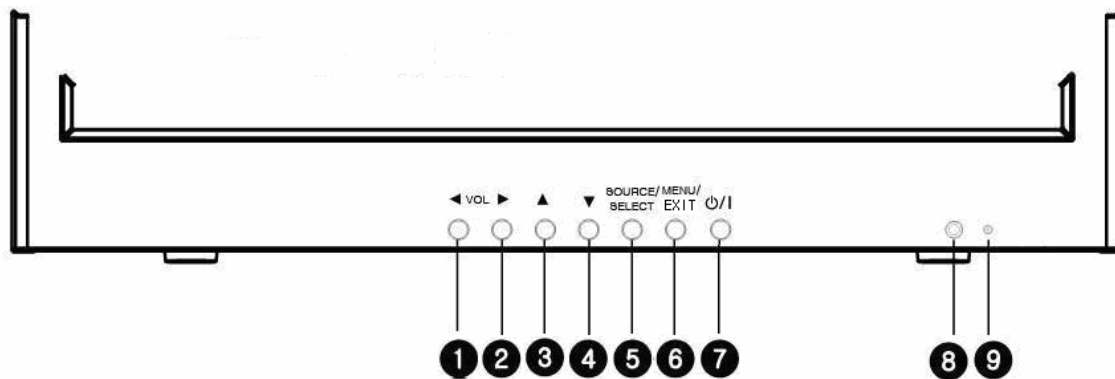

### 1 / 2. VOL

Adjust the volume and menu settings.

### 3 / 4. ▲ / ▼

These buttons allow user to enter the sub-menu of the activated function.

The up(▲) button is HOLD function and stop the Trigger & Auto switching functions.

### 5. SOURCE/SELECT

Select PC or video.

Select On Screen Display menu.

### 6. MENU/EXIT

Activate and exit the On Screen Display.

### 7. POWER ON/OFF(⏻/⏿)

Turns the power ON or OFF. There will be a few seconds delay before the display appears.

### 8. IR Sensor

Remote controller sensor.

## 9. POWER LED

The power LED lights with green when the power is turned ON.

The power is turned off by pressing the power switch again and the power LED goes Red.

# CONTROLS AND FUNCTIONS

8 ..... *INSTRUCTION MANUAL*

## OSD MENU DESCRIPTION

### A: CUSTOM MENU (Only Video Input)



- 1) Press the MENU button and then press the up(▲) or down(▼) button to select the Custom.
- 2) Press the up(▲) or down(▼) button to select the sub menu.
- 3) Press the left(◀) or right(▶) button to adjust the picture setting.
- 4) Press the MENU button to save.

**Brightness:** Increase or decrease the intensity of the image.

**Contrast:** Increase or decrease the intensity (lightness or dimness) of the image.

**Color:** Increase or decrease the colour of the picture.

**Tint:** Increase or decrease the tint of the picture.

**Sharpness:** Increase or decrease the sharpness of the picture.

## A: CUSTOM MENU (For HDMI, DVI & PC Input)



1) Press the MENU button and then press the up(▲) or down(▼) button to select the Custom.

2) Press the up(▲) or down(▼) button to select the sub menu.

# CONTROLS AND FUNCTIONS

3) Press the left(◀) or right(▶) button to adjust the picture setting.

4) Press the MENU button to save.

## B. Picture / Sound Menu (Only Video Input)

### 1. Picture Mode

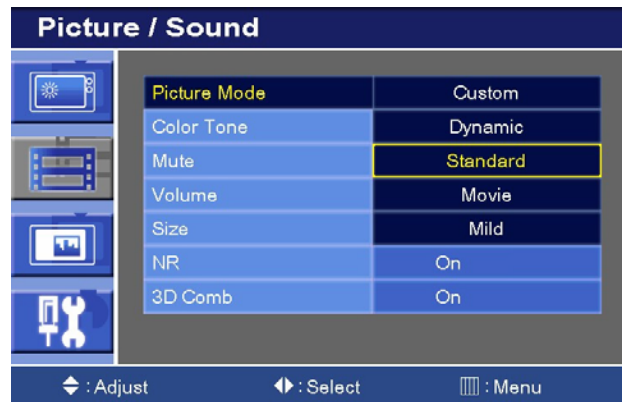
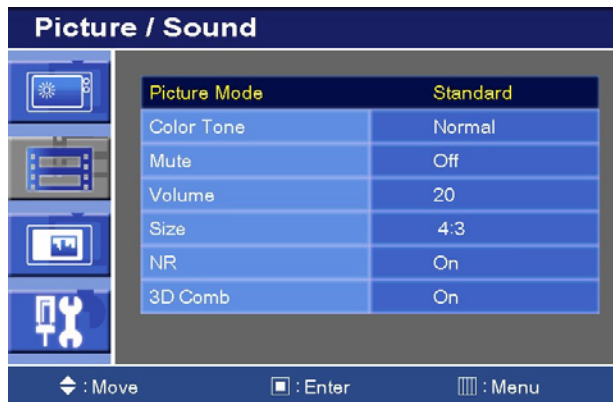

- 1) Press the MENU button and then press the up(▲) or down(▼) button to select the Picture / Sound.
- 2) Press the right(▶) or SOURCE/SELECT button.
- 3) Press the up(▲) or down(▼) button to select the Picture Mode.
- 4) Press the right(▶) or SOURCE/SELECT button.
- 5) Press the up(▲) or down(▼) button to select the Picture Mode option.
- 6) Press the MENU button to save

## 2. Color Tone

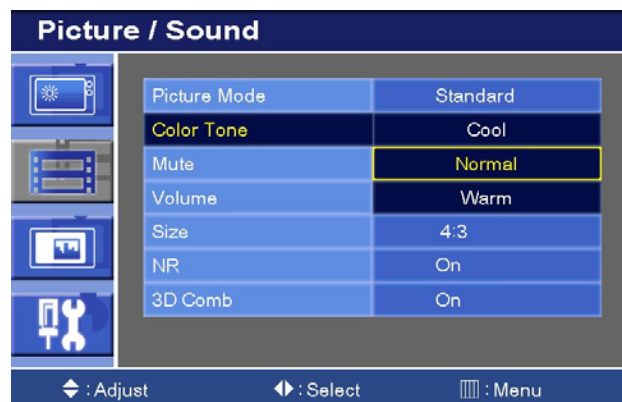
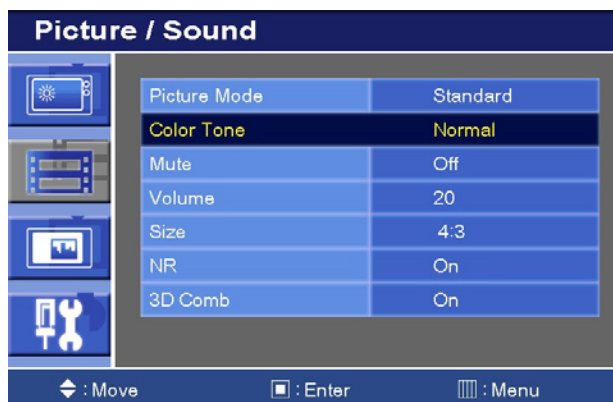

- 1) Press the up(▲) or down(▼) button to select the Color Tone.
- 2) Press the right(▶) or SOURCE/SELECT button.
- 3) Press the up(▲) or down(▼) button to select the Color Tone option.

# CONTROLS AND FUNCTIONS

4) Press the MENU button to save.

10 ..... INSTRUCTION MANUAL

## 3. Mute

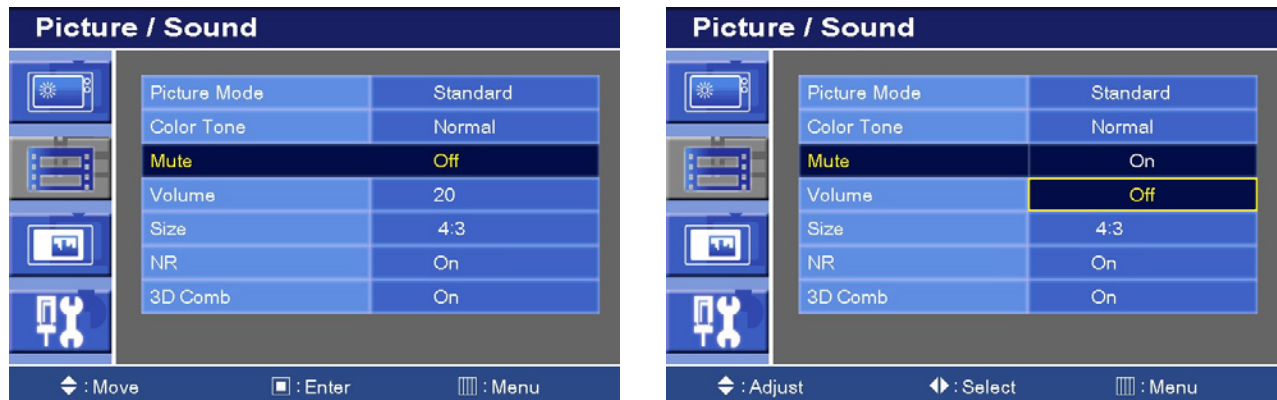

1) Press the up(▲) or down(▼) button to select the Mute.

2) Press the right(▶) or SOURCE/SELECT button.

3) Press the up(▲) or down(▼) button to select the On or Off.

4) Press the MENU button to save.

## 4. Volume

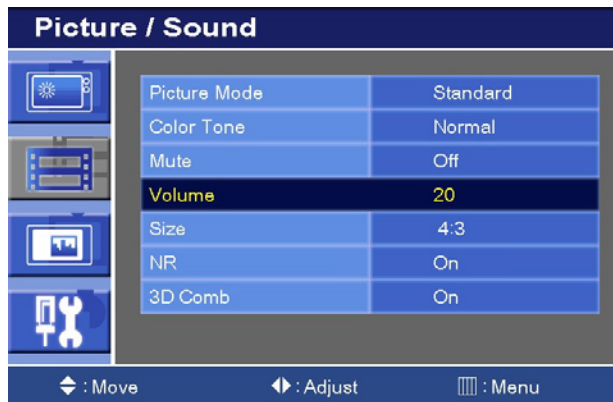

- 1) Press the up(▲) or down(▼) button to select the Volume
- 2) Press the left(◀) or right(▶) button to adjust Volume setting.
- 3) Press the MENU button to save.

# CONTROLS AND FUNCTIONS

## 5. Size

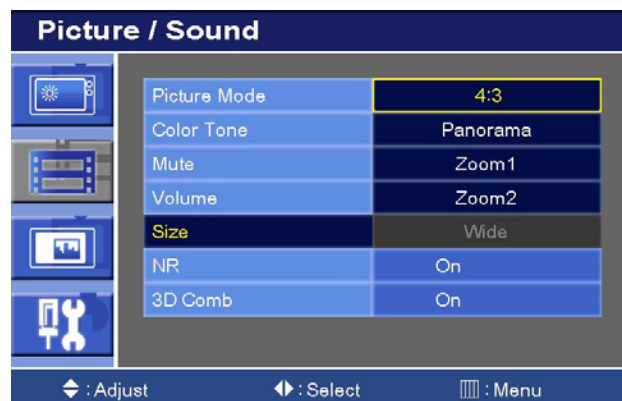
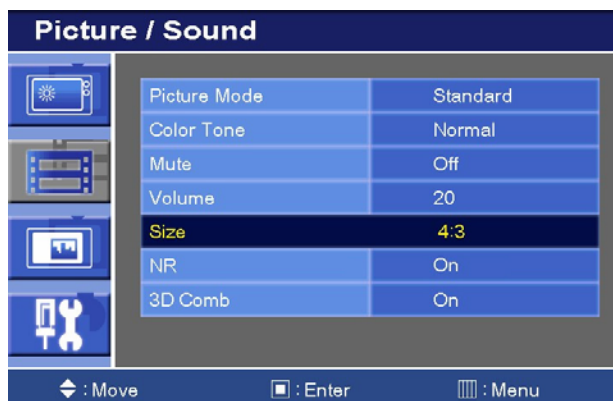



- 1) Press the up(▲) or down(▼) button to select the Size
- 2) Press the right(▶) or SOURCE/SELECT button.
- 3) Press the up(▲) or down(▼) button to select the Size option.
- 4) Press the MENU button to save.

## 6. NR

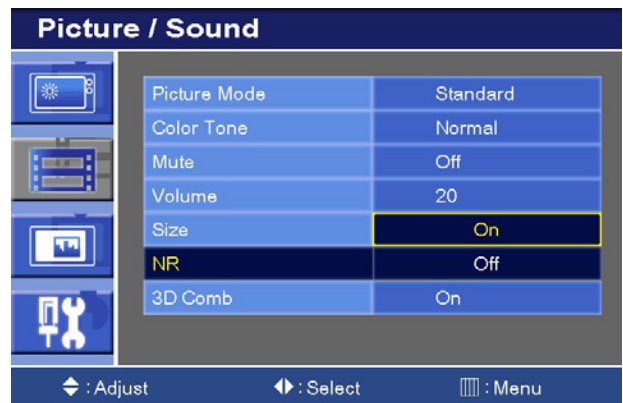
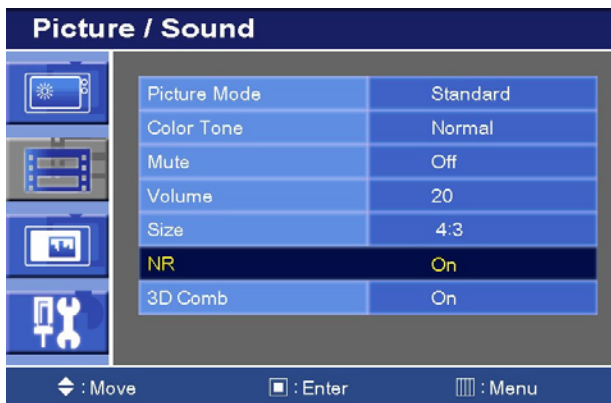

- 1) Press the up(▲) or down(▼) button to select the NR.
- 2) Press the right(▶) or SOURCE/SELECT button.
- 3) Press the up(▲) or down(▼) button to select the On or Off.
- 4) Press the MENU button to save.

# CONTROLS AND FUNCTIONS

## 7. 3D Comb

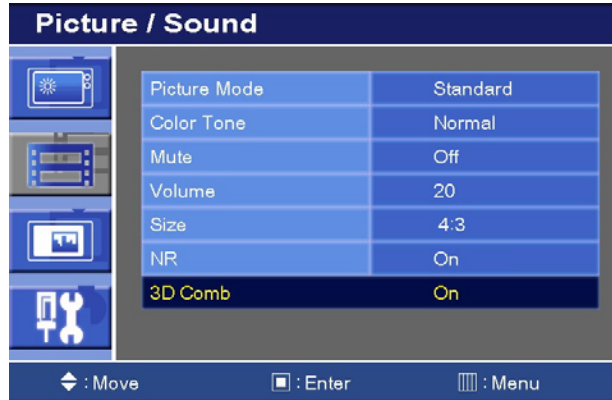

- 1) Press the up(▲) or down(▼) button to select the 3D Comb.
- 2) Press the right(▶) or SOURCE/SELECT button.
- 3) Press the up(▲) or down(▼) button to select the On or Off.
- 4) Press the MENU button to save.

## B. Picture / Sound Menu (For HDMI, DVI & PC Input)

### 1. Picture Mode

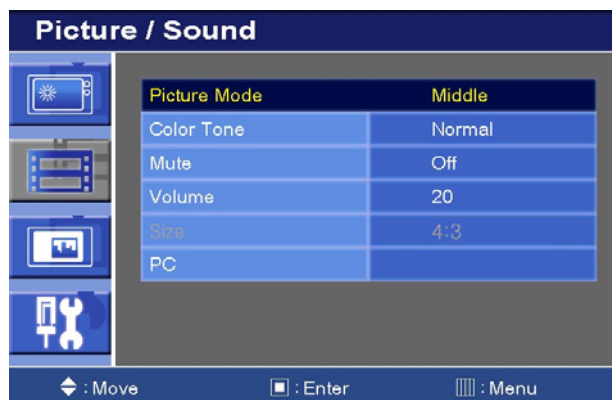

- 1) Press the MENU button and then press the up(▲) or down(▼) button to select the Picture/Sound.
- 2) Press the right(▶) or SOURCE/SELECT button.
- 3) Press the up(▲) or down(▼) button to select the Picture Mode.

4) Press the right(▶) or SOURCE/SELECT button.

5) Press the up(▲) or down(▼) button to select the Picture Mode option.

# CONTROLS AND FUNCTIONS

6) Press the MENU button to save.

## 2-1. Color Tone

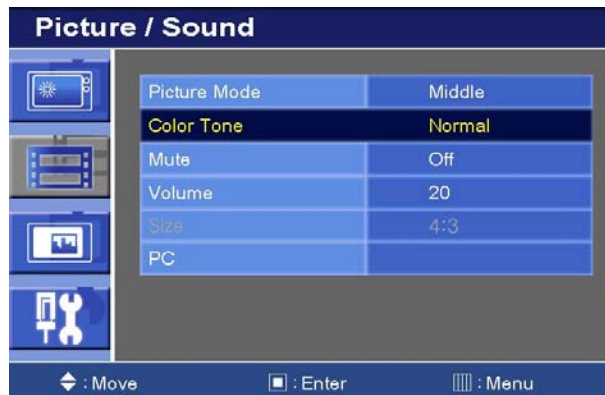

1) Press the up(▲) or down(▼) button to select the Color Tone.

2) Press the right(▶) or SOURCE/SELECT button.



- 3) Press the left(▶) or SOURCE/SELECT button again.
- 4) Press the up(▲) or down(▼) button to select the Color Tone option.
- 5) Press the MENU button to save.

# CONTROLS AND FUNCTIONS

## 2-2. Color Tone (Custom)

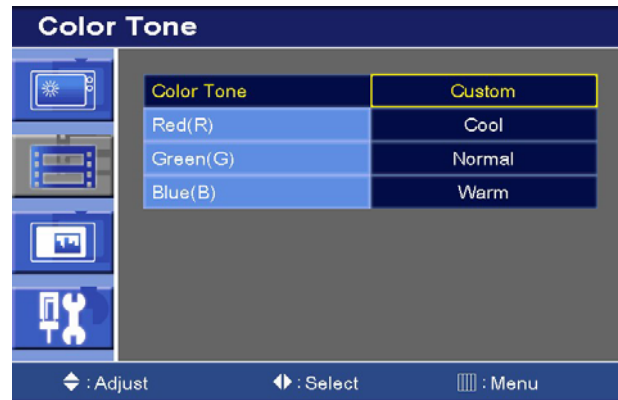

- 1) Press the up(▲) or down(▼) button to select the Custom in the Color Tone.
- 2) Press the Menu button to save.

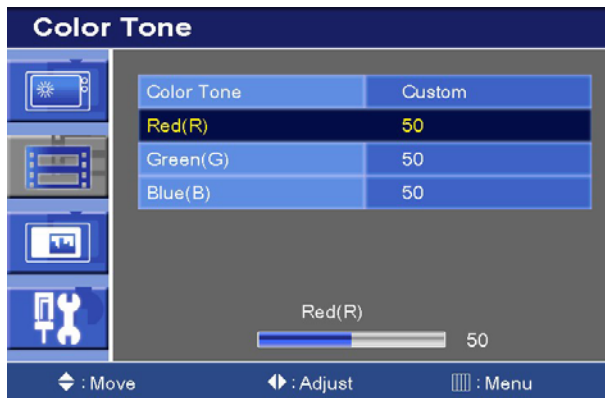

- 3) Press the up(▲) or down(▼) button to select the Red(R), Green(G) or Blue(B).
- 4) Press the left(◀) or right(▶) button to adjust color density.
- 5) Press the MENU button to save.

# CONTROLS AND FUNCTIONS

## 3. Size

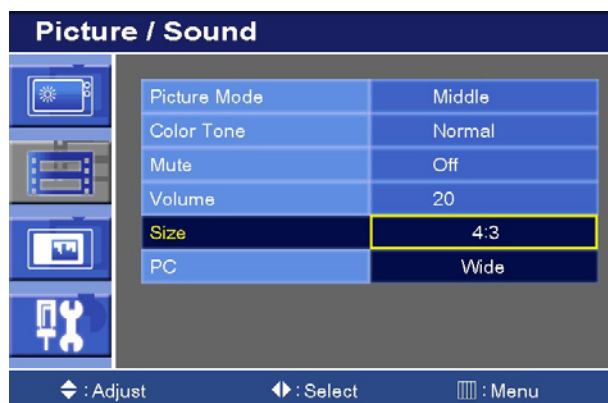
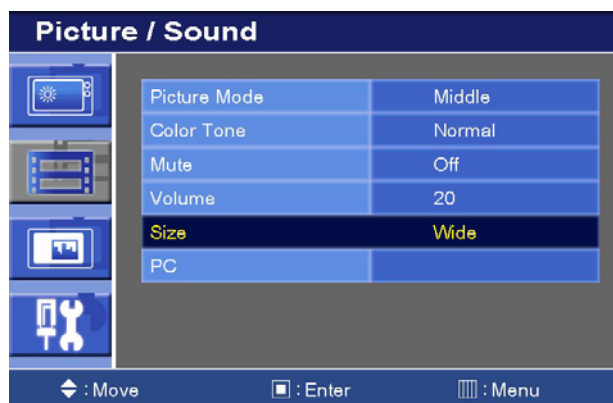

- 1) Press the up(▲) or down(▼) button to select the Size.
- 2) Press the right(▶) or SOURCE/SELECT button.
- 3) Press the up(▲) or down(▼) button to select the Size option.

## 4. PC control (Only PC Input)

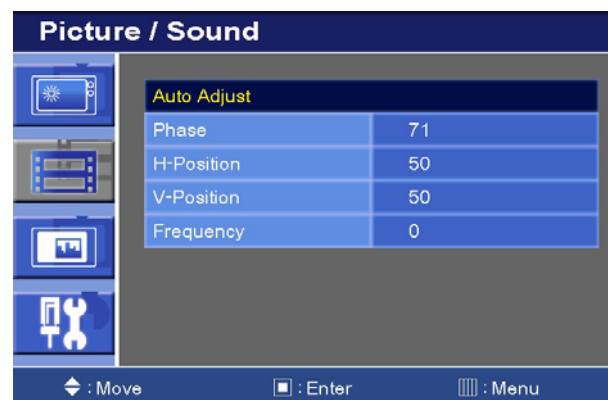

- 1) Press the up(▲) or down(▼) button to select the PC.
- 2) Press the right(▶) or SOURCE/SELECT button.
- 3) Press the up(▲) or down(▼) button to select the PC sub menu.

- 4) Press the right(▶) or SOURCE/SELECT button.
- 5) Press the left(◀) or right(▶) button to adjust the PC setting.
- 6) Press the MENU button to save.

**Auto Adjust:** Auto geometry adjustment.

**Phase:** Adjust the number of horizontal picture elements.

# CONTROLS AND FUNCTIONS

**H-Position:** Move image horizontally on screen right or left.

**V-Position:** Move image vertically on screen up or down.

**Frequency:** Adjust the vertical noise of screen image.

## C. PIP MENU (Only Video Input)



- 1) Press the MENU button and then press the up(▲) or down(▼) button to select the PIP.

### 1. PIP

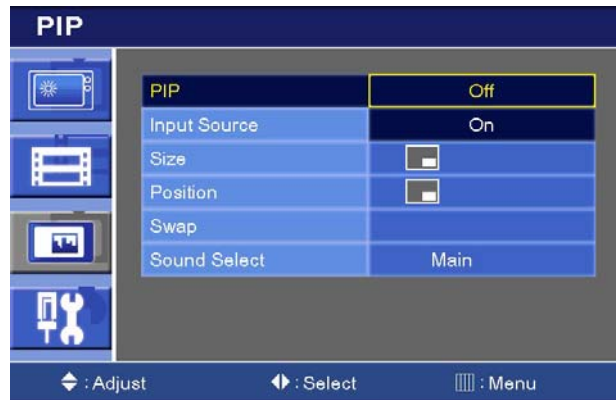

- 1) Press the right(▶) or SOURCE/SELECT button.
- 2) Press up(▲) or down(▼) button to select the On or Off.
- 3) Press the MENU button to save.

# CONTROLS AND FUNCTIONS

## 2. Input Source



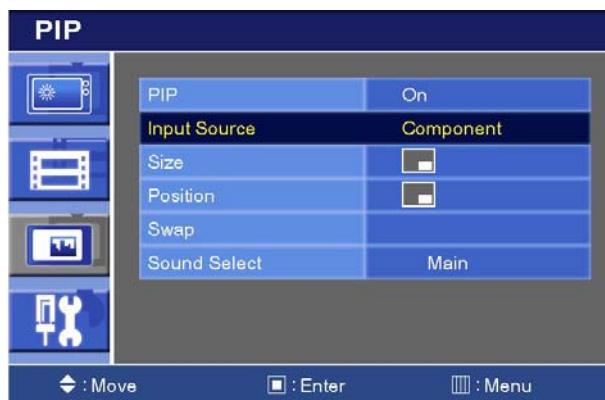

- 1) Press the up(▲) or down(▼) button to select the Input Source.
- 2) Press the right(▶) or SOURCE/SELECT button.
- 3) Press the up(▲) or down(▼) button to select the Source option.
- 4) Press the MENU button to save.

### 3. Size

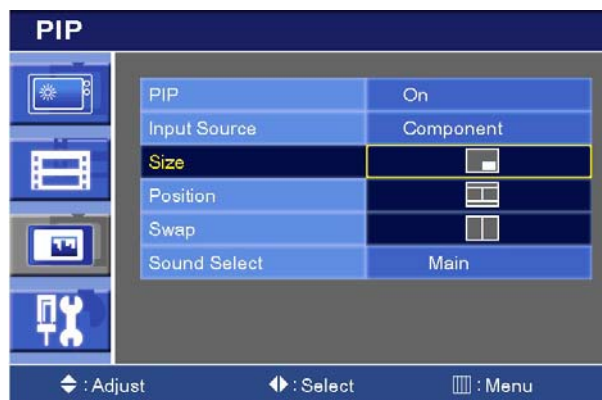
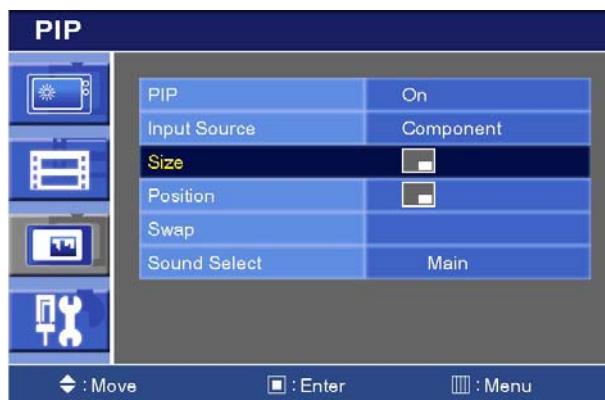

- 1) Press the up(▲) or down(▼) button to select the Size.
- 2) Press the right(▶) or SOURCE/SELECT button.
- 3) Press the up(▲) or down(▼) button to select the Size option.
- 4) Press the MENU button to save.

# CONTROLS AND FUNCTIONS

## 4. Position

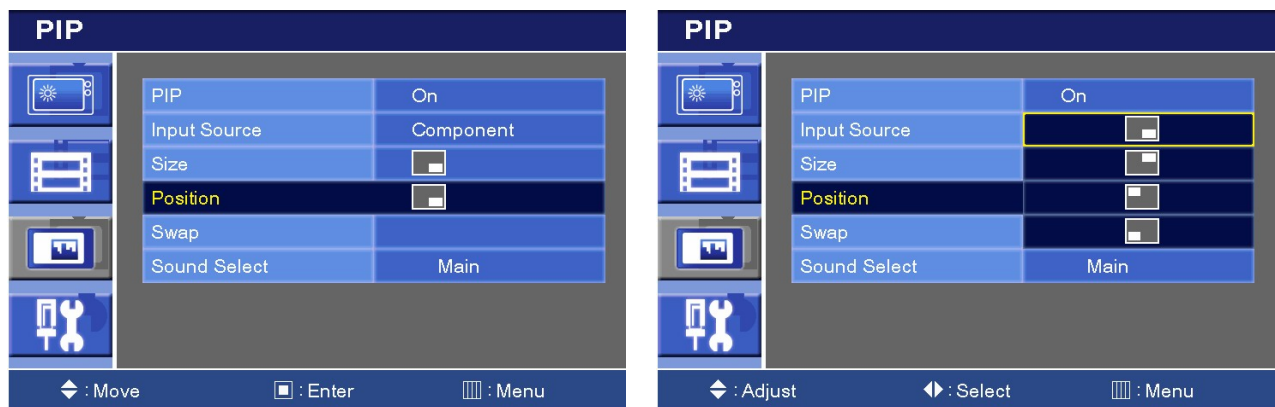

- 1) Press the up(▲) or down(▼) button to select the Position.
- 2) Press the right(▶) or SOURCE/SELECT button.
- 3) Press the up(▲) or down(▼) button to select the Position option.
- 4) Press the MENU button to save.

## 5. Swap



1) Press the up(▲) or down(▼) button to select the Swap.

2) Press the right(▶) or SOURCE/SELECT button to swap the main image for the sub one.

# CONTROLS AND FUNCTIONS

## 5. Sound Select

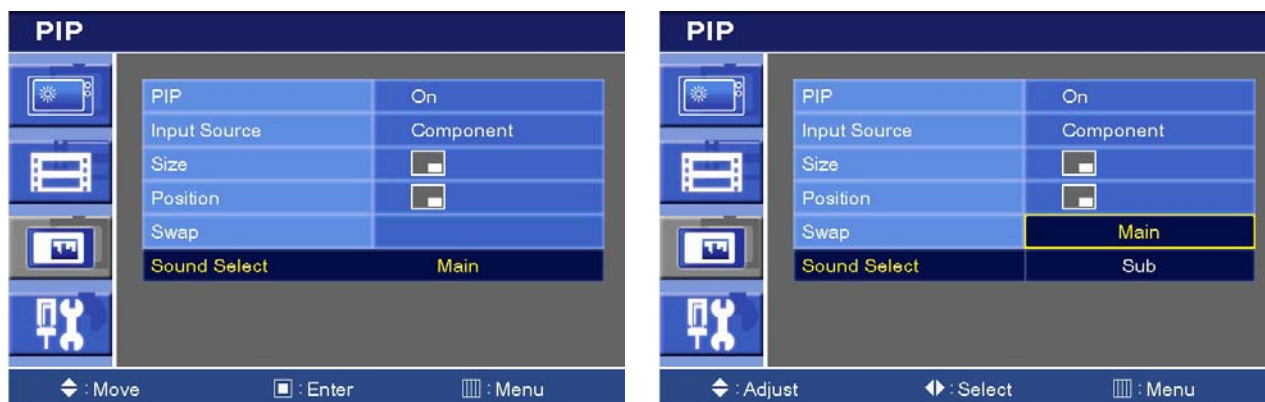

1) Press the up(▲) or down(▼) button to select the Sound Select.

2) Press the right(▶) or SOURCE/SELECT button.

3) Press the up(▲) or down(▼) button to select the Sound Select option.

4) Press the MENU button to save.

## C. PIP MENU (For HDMI, DVI & PC Input)

### 1. Input Source

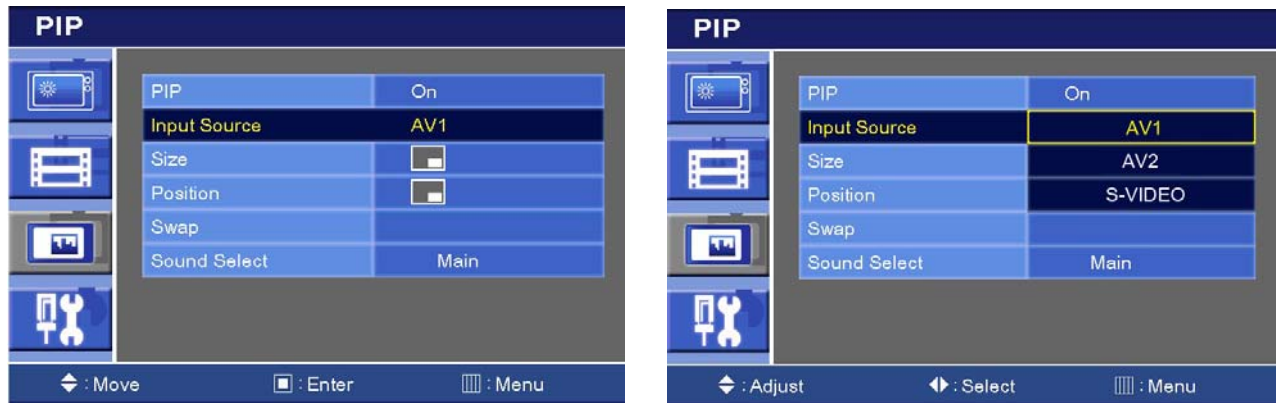

- 1) Press the up(▲) or down(▼) button to select the Input Source.
- 2) Press the right(▶) or SOURCE/SELECT button.
- 3) Press the up(▲) or down(▼) button to select the Input Source option.
- 4) Press the MENU button to save.

# CONTROLS AND FUNCTIONS

## D. SETUP MENU



1) Press the MENU button and then press the up(▲) or down(▼) button to select the Setup.

### 1. Reset

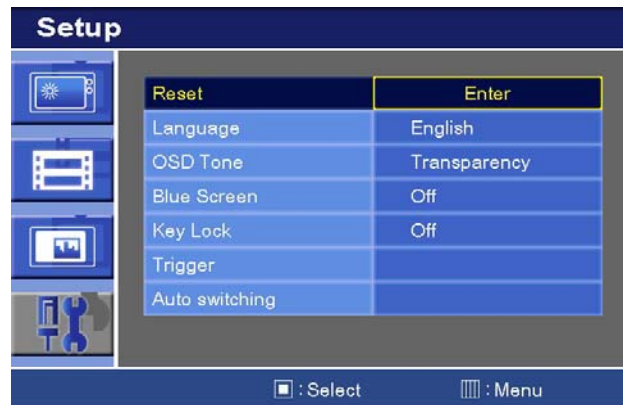

1) Press the right(▶) or SOURCE/SELECT button

2) Press the right(▶) or SOURCE/SELECT button again.

3) Press SOURCE/SELECT button to execute the reset.

**Reset:** All settings go to the factory initialization.

# CONTROLS AND FUNCTIONS

## 2. Language



- 1) Press the up(▲) or down(▼) button to select the Language.
- 2) Press the right(▶) or SOURCE/SELECT button.
- 3) Press the up(▲) or down(▼) button to select language.
- 4) Press the MENU button to save.

## 3. OSD Tone

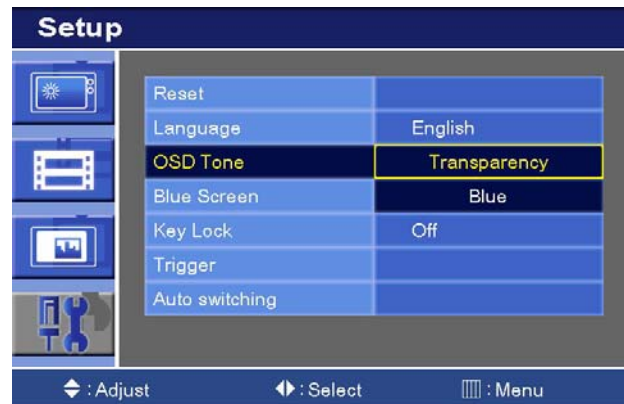

- 1) Press the up(▲) or down(▼) button to select the OSD Tone.
- 2) Press the right(▶) or SOURCE/SELECT button
- 3) Press the up(▲) or down(▼) button to select the OSD Tone option.
- 4) Press the MENU button to save.

# CONTROLS AND FUNCTIONS

## 4. Blue Screen



- 1) Press the up(▲) or down(▼) button to select the Blue Screen.
- 2) Press the right(□) or SOURCE/SELECT button.
- 3) Press the up(▲) or down(▼) button to select the On or Off.
- 4) Press the MENU button to save.

## 5. Key Lock

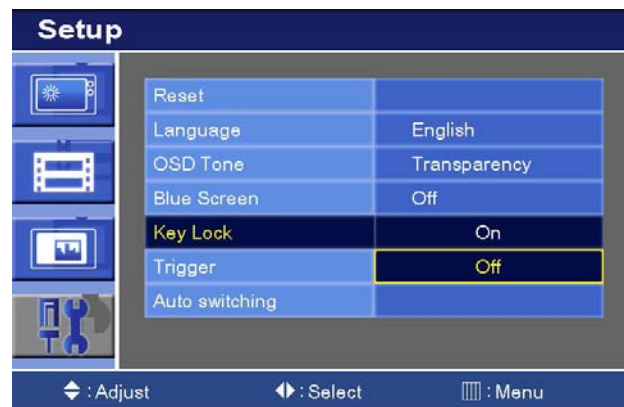

- 1) Press the up(▲) or down(▼) button to select the Key Lock.
- 2) Press the right(□) or SOURCE/SELECT button
- 3) Press the up(▲) or down(▼) button to select the On or Off
- 4) Press the MENU button to save.

### ※ How to unlock

- 1) **On the front key:** Press the SOURCE/SELECT and MENU button at the same time over **3 seconds.**
- 2) **On the Remote Controller:** The Remote Controller operates well because the Key Lock function is only allowed for the front key of this product.

# CONTROLS AND FUNCTIONS

## 6. Trigger



- 1) Press the up(▲) or down(▼) button to select the Trigger.
- 2) Press the right(▶) or SOURCE/SELECT button.

### 6-1. Trigger Enable

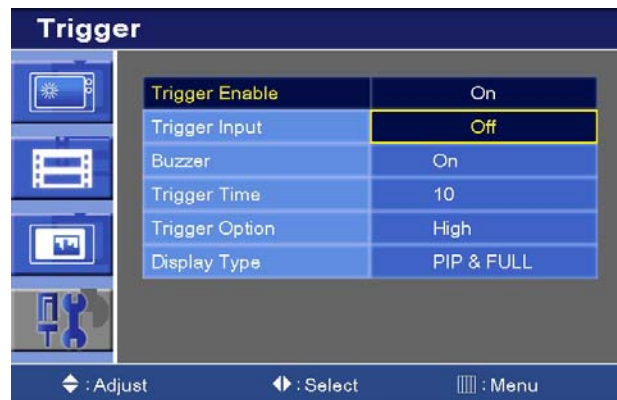
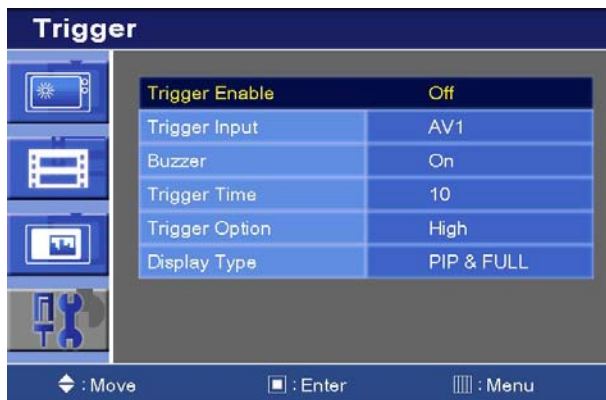

- 1) Press the up(▲) or down(▼) button to select the Trigger Enable.
- 2) Press the right(▶) or SOURCE/SELECT button.
- 3) Press the up(▲) or down(▼) button to select the On or Off.
- 4) Press the Menu button to save.



# CONTROLS AND FUNCTIONS

## 6-2. Trigger Input

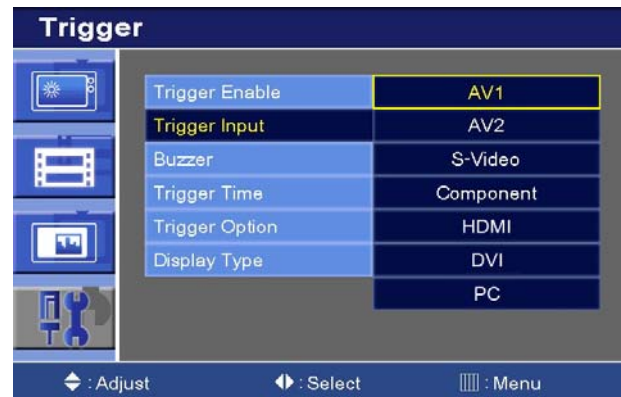
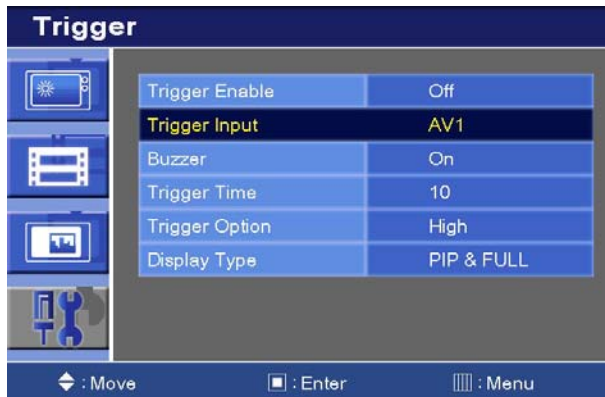

- 1) Press the up(▲) or down(▼) button to select the Trigger Input .
- 2) Press the right(▶) or SOURCE/SELECT button.
- 3) Press the up(▲) or down(▼) button to select the Trigger Input option.
- 4) Press the Menu button to save.

## 6-3. Buzzer

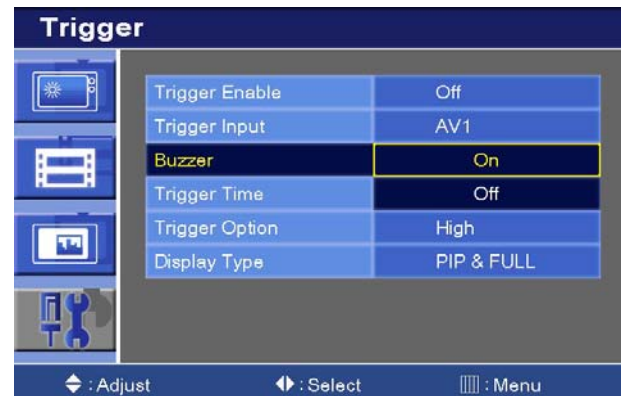
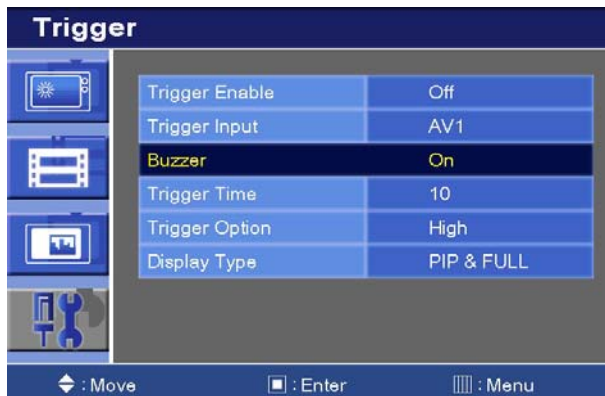

- 1) Press the up(▲) or down(▼) button to select the Buzzer.
- 2) Press the right(▶) or SOURCE/SELECT button.
- 3) Press the up(▲) or down(▼) button to select the On or Off.
- 4) Press the Menu button to save.

# CONTROLS AND FUNCTIONS

## 6-4. Trigger Time

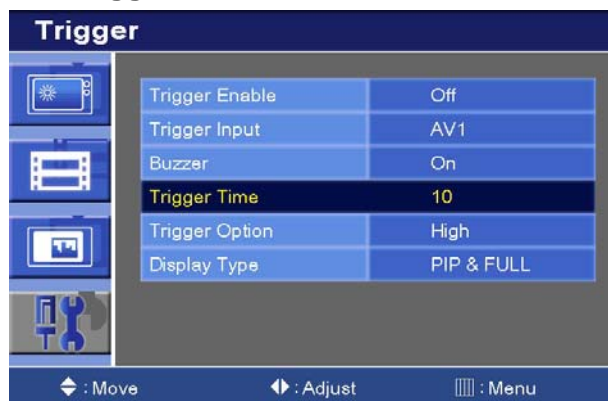

- 1) Press the up(▲) or down(▼) button to select the Trigger Time.
- 2) Press left(◀) or right(▶) button to adjust Trigger Time setting.
- 3) Press the MENU button to save.

## 6-5 Trigger Option

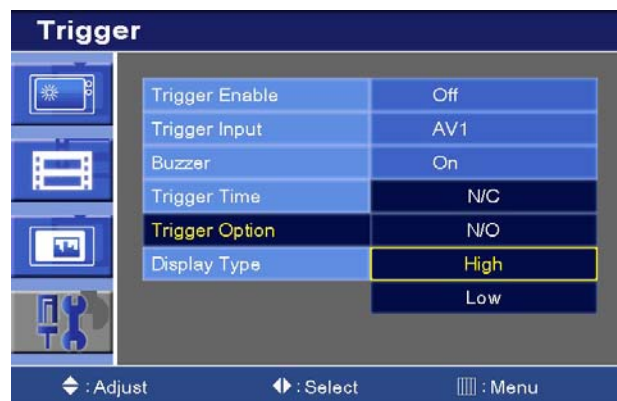
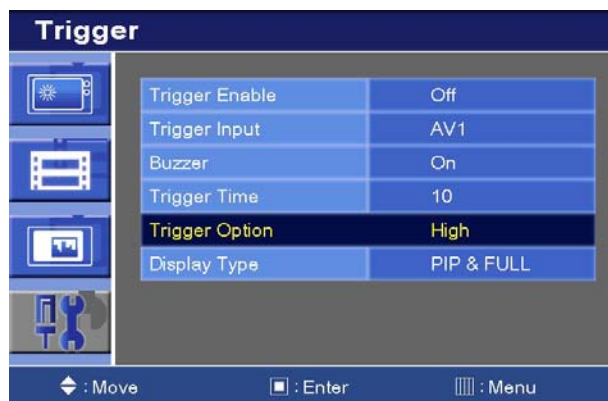

- 1) Press the up(▲) or down(▼) button to select the Trigger Option.
- 2) Press the right(◻) or SOURCE/SELECT button.
- 3) Press the up(▲) or down(▼) button to select the Trigger Option setting.
- 4) Press the Menu button to save.

**N/C (Normal Closed):** When Trigger cable is opened, Trigger function is activated.  
**N/O (Normal Opened):** When Trigger cable is closed, Trigger function is activated.  
**High:** When Trigger signal is high(2~5[V]), Trigger function is activated.

# CONTROLS AND FUNCTIONS

**Low:** When Trigger signal is low(0~0.6[V]), Trigger function is activated.

## 6-6. Display Type

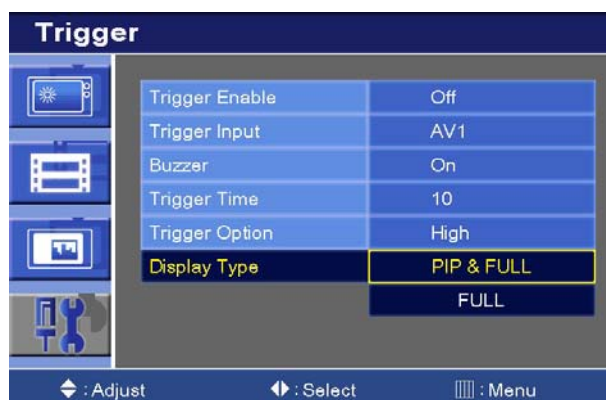
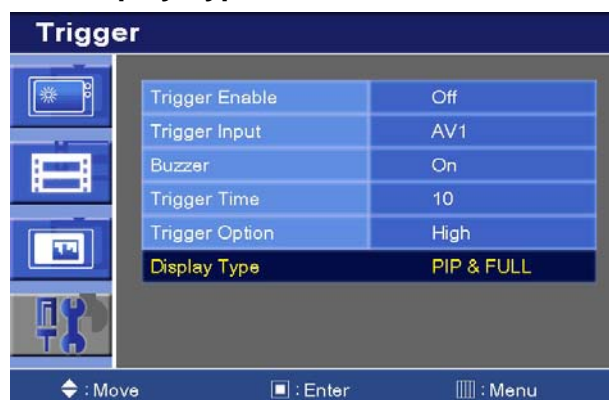

- 1) Press the up(▲) or down(▼) button to select the Display Type.
- 2) Press the right(▶) or SOURCE/SELECT button.
- 3) Press the up(▲) or down(▼) button to select the Display Type option.
- 4) Press the Menu button to save.

### PIP & FULL :

If the type of image in the trigger input is different with we are watching, trigger image will be displayed as a small screen at a corner which you selected in PIP menu.  
 Otherwise it will be displayed as a full screen.

**FULL :** Trigger image will be displayed as a full screen.

※ The Type of Image 1 : AV1, AV2 or S-Video.

The Type of Image 2 : Component, HDMI, DVI or PC.

# CONTROLS AND FUNCTIONS

**INSTRUCTION MANUAL** ..... 27

## 7. Auto switching



- 1) Press the up(▲) or down(▼) button to select the Auto switching.
- 2) Press the right(▶) or SOURCE/SELECT button.

### 7-1. Auto switching On/Off

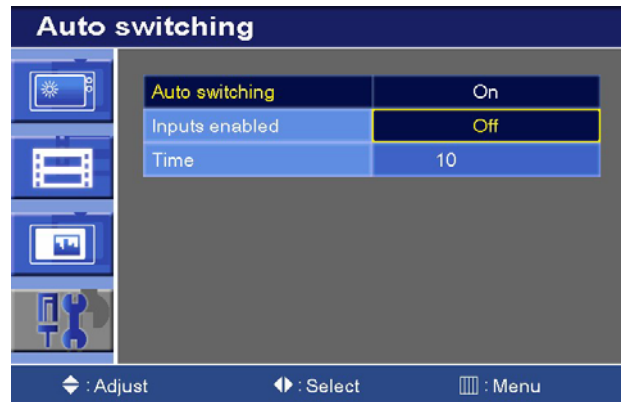
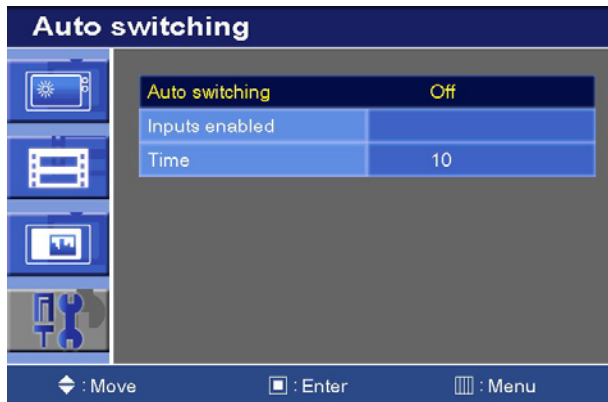

- 1) Press the right(□) or SOURCE/SELECT button.
- 3) Press the up(▲) or down(▼) button to select the On or Off .
- 4) Press the Menu button to save.

# CONTROLS AND FUNCTIONS

## 7-2. Auto switching Inputs enabled

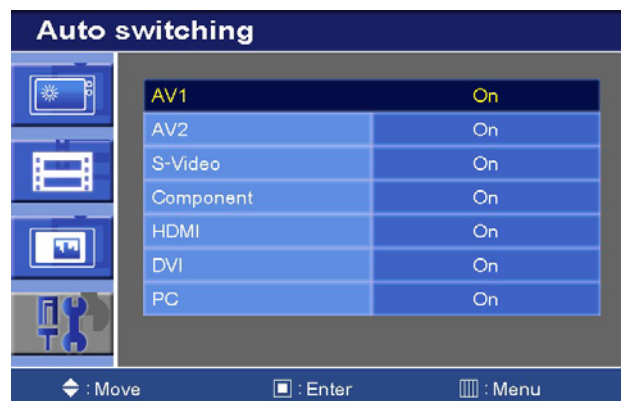
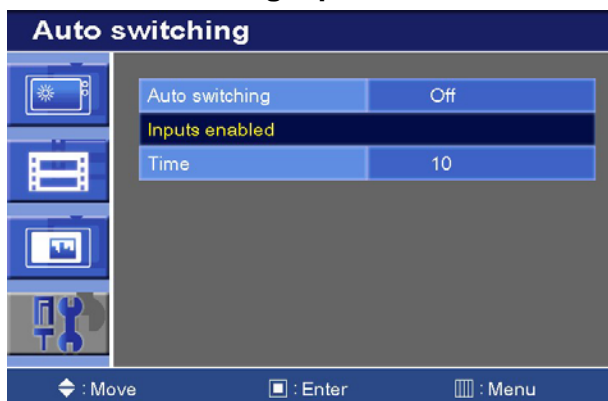

- 1) Press the up(▲)or down(▼) button to select the Inputs enabled.
- 2) Press the right(▶) or SOURCE/SELECT button.
- 3) Press the up(▲) or down(▼) button to select the Input.
- 4) Press the right(▶) or SOURCE/SELECT button.

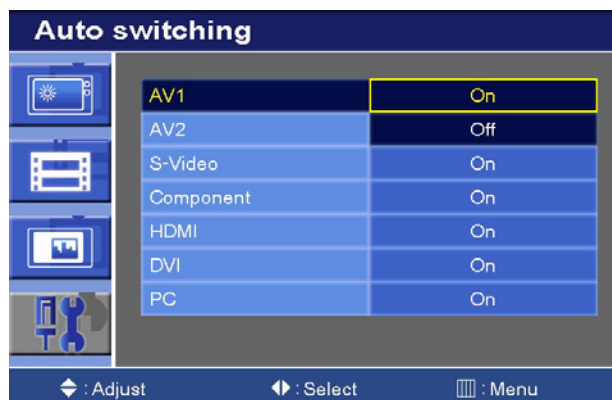

- 1) Press the up(▲) or down(▼) button to select the On or Off.
- 2) Press the Menu button to save.

# CONTROLS AND FUNCTIONS

## 7-3. Auto switching Time

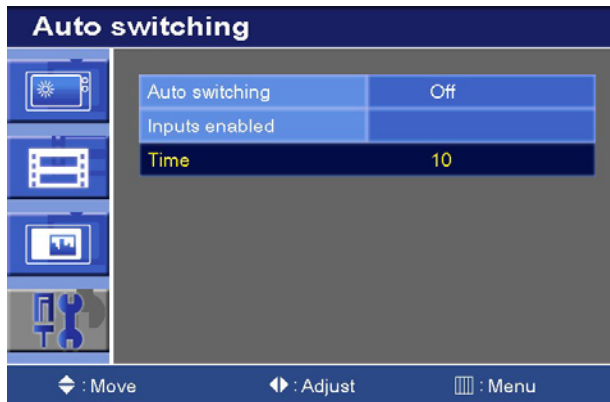

- 1) Press the up(▲) or down(▼) button to select the Time.
- 2) Press the left(◀) or right(▶) button to adjust the Time setting.
- 3) Press the MENU button to save.

# MOUNTING GUIDE

Using the VESA standard wall mount design and the 100mm hole pattern on the back panel to install the LCD monitor to the wall.

## Wall-mount Installation (Option)

1. The Monitor fixing bracket to the monitor using the fixing screws provided.
2. The monitor fixing bracket assembled with monitor

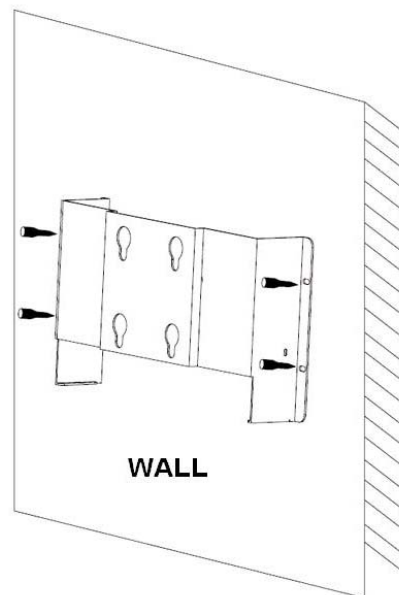
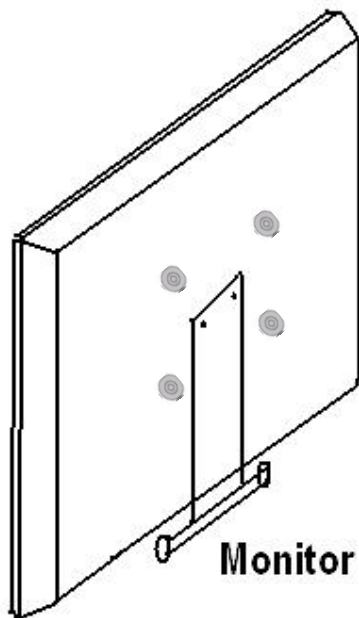



# D-SUB CONNECTOR PIN ASSIGNMENTS

## ► PIN ASSIGNMENTS

Pin 1	RED VIDEO	9	
2	GREEN VIDEO	10	SIGNAL CABLE DETECT
3	BLUE VIDEO	11	GROUND
4	GROUND	12	SDA(for DDC)
5	GROUND	13	H-SYNC.(or H+V SYNC.)
6	RED GROUND	14	V-SYNC.
7	GREEN GROUND	15	SCL(for DDC)
8	BLUE GROUND		

## D-SUB

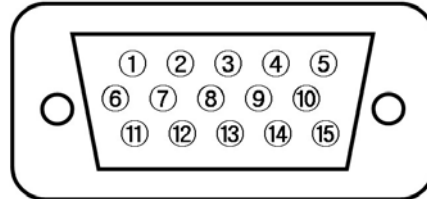

## ► ACCESSORIES

1. Power cord
2. Power adaptor (Built-in)
3. User's manual
4. PC cable
5. Trigger cable (Option)
6. Stereo cable (Option)
7. Remote controller (Option)
8. Batteries (Option)
9. Wall mount (Option)
10. Rack mount (Option)

# POWER MANAGEMENT

This monitor features a power management system to “power down” upon receipt of the VESA DPMS(The display power management signaling) from a VESA DPMS video card.

The VESA DPMS-compliant video card performs this signaling system through not sending horizontal, vertical, or sync signal.

This monitor enters an appropriate mode through identifying each of the three modes of the signaling system.

## **POWER CONSUMPTION : < 50W**

### **LED INDICATOR**

The power management feature of the monitor is comprised of four stages: On(Green), Standby, Suspend, Active off(Red on/off 1 sec) and Unsupported mode(Green).

<b>MODE</b>	<b>LED COLOR</b>	<b>MONITOR OPERATION</b>
<b>ON</b>	GREEN	Normal Operation
<b>STANDBY</b>	RED ON/OFF 1 SEC	Screen blanks after preset idle time
<b>SUSPEND</b>		And some electronic circuits or all
<b>ACTIV OFF</b>		Circuitry in the monitor shut down.
<b>UNSUPPORTES MODE</b>	GREEN	Normal operation but the on screen Display will show error message
<b>POWER OFF</b>	RED	Not Operation

# SPECIFICATIONS

	17"	19"
<b>LCD- Type</b>	17" Diagonal AM-TFT(Active-Matrix)	19" Diagonal AM-TFT(Active-Matrix)
	Pixel pitch(mm) : 0.264(H) x 0.264(V)	Pixel pitch(mm) : 0.294(H) x 0.294(V)
	BRIGHTNESS: 300cd/m <sup>2</sup> (Typical)	BRIGHTNESS: 300cd/m <sup>2</sup> (Typical)
	CONTRAST RATIO: 1000:1(Typical)	CONTRAST RATIO: 800:1(Typical)
	RESPONSE TIME: 5msec(Typical)	RESPONSE TIME: 5msec(Typical)
<b>RESOLUTION (H x V)</b>	1280X1024 @60Hz	1280X1024 @60Hz
<b>FREQUENCY</b>	HORIZONTAL: 31 ~ 80KHz VERTICAL: 56-75Hz	HORIZONTAL: 31~ 80KHz VERTICAL: 56-75Hz
<b>INPUT SIGNAL</b>	VIDEO(2ch input 1.0Vp-p, 75Ω terminated, loop-through out)	
	S-VIDEO(1ch input (Y/C) , loop-through out)	
	COMPONENT(Y,Pb,Pr, Sound L/R)	
	DVI D(Digital Video Interface)	
	HDMI(High Definition Multimedia Interface)	
	PC RGB	
	AV(composite) Sound in/Out	
	PC Stereo Sound	
	Audio Out	
<b>ACTIVE DISPLAY AREA (W x H)</b>	337.9 mm x 270.3 mm (13.3" X 10.64")	376.32mm X 301mm (14.82" X 11.85")
<b>PACKING DIMENSIONS (W x H x D)</b>	477mm X 543mm X 205mm (18.78" X 21.38" X 8.07")	477mm X 543mm X 205mm (18.78" X 21.38" X 8.07")
<b>WEIGHT</b>	Net Weight : 6.42Kg (14.15 lbs)	Net Weight : 7.17Kg (15.81 lbs)

	Gross Weight : 8.19Kg (18.06 lbs))	Gross Weight : 8.94Kg (19.71 lbs)
<b>ELECTRICAL RATINGS</b>	DC 12V/ 3.0A	DC 12V/ 3.5A

►► **NOTE :**

# TROUBLESHOOTING GUIDE

Technical specifications are subject to change without notice.

TROUBLE	TROUBLESHOOTING TIP
<b>No image on display screen</b>	<ol style="list-style-type: none"> <li>1. Check that power cord of the Monitor have been connected securely into wall outlet or grounded extension cable or strip.</li> <li>2. Power switch should be in the ON position and LED is lit.</li> <li>3. Check that the Brightness and/or the Contrast adjustments of the Display have not been turned down to minimum levels.</li> </ol>
<b>"Going to Sleep" message on screen</b>	<ol style="list-style-type: none"> <li>1. The signal cable should be completely connected to the video card/computer.</li> <li>2. The video card should be completely seated in its slot and the computer is switched ON.</li> </ol>
<b>Display image is not centered, too small or too large in PC mode</b>	Push the down key in front side or Auto key in remote controller.
<b>Vertical or Horizontal noise is present in the picture</b>	Adjust Clock and Phase in the OSD.

## WEEE Symbols

**Correct Disposal of This Product  
(Waste Electrical & Electronic Equipment)**

(Applicable in the European Union and other European countries with separate collection systems)

This marking shown on the product or its literature, indicates that it should not be disposed with other household wastes at the end of its working life. To prevent possible harm to the environment or human health from uncontrolled waste disposal, please separate this from other types of wastes and recycle it responsibly to promote the sustainable reuse of material resources. Household users should contact either the retailer where they purchased this product, or their local government office, for details of where and how they can take this item for environmentally safe recycling. Business users should contact their supplier and check the terms and conditions of the purchase contract. This product should not be mixed with other commercial wastes for disposal.



## **EverFocus Electronics Corp.**

### **Taiwan - Headquarter Office**

12F, No.79 Sec.1 Shin-Tai Wu Road,  
Hsi-Chi, Taipei, Taiwan  
Tel: +886-2-26982334  
Fax: +886-2-26982380

### **China - Beijing Office**

Room 609, Technology Trade Building,  
Shangdi Information Industry Base,  
Haidian District, Beijing China  
Tel: +86-10-62971096  
Fax: +86-10-62971423

### **Europe - Germany Office**

Albert-Einstein-Strasse 1,  
D-46446 Emmerich, Germany  
Tel: +49-2822-9394-0  
Fax: +49-2822-939495

### **Japan Office**

1809 WBG Marive East 18F,  
2-6 Nakase, Mihama-ku,  
Chiba City 261-7118, Japan  
Tel: +81-43-212-8188  
Fax: +81-43-297-0081

### **USA - California Office**

1801 Highland Ave. Unit A  
Duarte, CA 91010 ,U.S.A  
Tel: +1-626-844-8888  
Fax: +1-626-844-8838

### **USA - New York Office**

415 Oser Ave Unit S  
Hauppauge, NY 11788  
Sales: +1-631-436-5070  
Fax: +1-631-436-5027

	<p>Your EverFocus product is designed and manufactured with high quality materials and components which can be recycled and reused.</p> <p>This symbol means that electrical and electronic equipment, at their end-of-life, should be disposed of separately from your household waste.</p> <p>Please, dispose of this equipment at your local community waste collection/recycling centre.</p> <p>In the European Union there are separate collection systems for used electrical and electronic product.</p> <p>Please, help us to conserve the environment we live in!</p>	<p>Ihr EverFocus Produkt wurde entwickelt und hergestellt mit qualitativ hochwertigen Materialien und Komponenten, die recycelt und wieder verwendet werden können.</p> <p>Dieses Symbol bedeutet, dass elektrische und elektronische Geräte am Ende ihrer Nutzungsdauer vom Hausmüll getrennt entsorgt werden sollen.</p> <p>Bitte entsorgen Sie dieses Gerät bei Ihrer örtlichen kommunalen Sammelstelle oder im Recycling Centre.</p> <p>Helfen Sie uns bitte, die Umwelt zu erhalten, in der wir leben!</p>
---	--	---



P/N : L39ME0171 Rev.2